

Gen3™ elevator

A platform for possibility

HOISTWAY DIMENSIONAL DATA



OTIS



A FULLY CONNECTED
PLATFORM



Solutions for your world

Our Gen3 elevator blends convenience, style and performance to deliver a new passenger experience that adds value to any residential, commercial, hospitality, medical or industrial building.

THE GEN3 FAMILY OF ELEVATORS

+ Gen3 Edge

+ Gen3 Peak

Gen3 Edge™

PASSENGER ELEVATOR

Travel height maximum	80' (24 m)	100' (30 m)	150' (45 m)
Maximum stops	10	13	16
Speed (fpm)	150 (.76 m/s)	200 (1.02 m/s)	350 (1.78 m/s)
Capacity (lbs)	2,100 - 4,000		

Rated duty	2,100 lbs (953 kg)	2,500 lbs (1134 kg)	3,000 lbs (1361 kg)	3,500 lbs (1588 kg)	4,000 lbs (1814 kg) ²
A Clear car width ¹	5'-8 5/16" (1735 mm)	6'-5 9/16" (1970 mm)		7'-5 9/16" (2275 mm)	
B Clear car depth for front openings ¹	4'-3 9/16" (1309 mm)	5'-0 3/16" (1528 mm)	5'-5 9/16" (1665 mm)		
Clear car depth for front & rear openings ¹	4'-4 1/8" (1324 mm)	5'-0 3/4" (1543 mm)	5'-6 1/8" (1680 mm)		
C Clear cab height ³	7'-9" (2362 mm) or 9'-9" (2972 mm)				
D Door width	3'-0" (914 mm)	3'-6" (1067 mm)		4'-0" (1219 mm)	
Door type	Single slide	Center opening or single slide		Center Opening	
E Door height	7'-0" (2134 mm) or 8'-0" (2438 mm)				
F Hoistway single width ^{9,10} non-seismic	7'-7" (2311 mm)	8'-4" (2540 mm)		9'-4" (2845 mm)	
Hoistway single width ^{9,10} seismic	7'-9" (2362 mm)	8'-6" (2591 mm)		9'-6" (2896 mm)	
G Hoistway double width ^{7,9,10} non-seismic	15'-6" (4724 mm)	17'-0" (5182 mm)		19'-0" (5791 mm)	
Hoistway double width ^{7,9,10} seismic	15'-10" (4826 mm)	17'-4" (5283 mm)		19'-4" (5893 mm)	
H Hoistway depth for front openings	5'-9" (1753 mm)	6'-4" (1930 mm)	6'-11" (2108mm)		
Hoistway depth for front & rear openings	6'-3 1/4" (1911 mm)	6'-11 7/8" (2130 mm)	7'-5 1/4" (2267 mm)		

I Clear overhead to hoist beam ^{4,5}	150 fpm (0.76 m/s)	200 fpm (1.02 m/s)	350 fpm (1.78 m/s)
7'-9" (2362 mm) cab height	12'-7" (3836 mm)	12'-8" (3861mm)	13'-7" (4140 mm)
9'-9" (2972 mm) cab height	14'-7" (4445 mm)	14'-8" (4471mm)	15'-7" (4750 mm)
J Minimum pit depth ^{6,8}	4'-0" (1219 mm) or 5'-0" (1524 mm)	4'-6" (1372 mm) or 5'-6" (1676 mm)	

K Optional control closet or room ⁷	
Control closet	Hoistway depth x 3'-10" (1168 mm)
Control room	Hoistway depth x 5'-9" (1753 mm)
Control room-duplex	Hoistway depth x 7'-6" (2286 mm)

1. Clear car dimensions may vary depending on interior finishes.
 2. 4000P and service elevators @350 fpm require a control closet.
 3. Clear cab height varies by ceiling type and floor recess.
 4. Allow a minimum of 4" (102 mm) between top of safety beam and top of hoistway.
 5. For seismic area, multi-car groups, or pre 2008 ASME A17.1 Safety Code for Elevators, please contact your Otis representative for clear overhead dimensions.

6. Some locations require a 5'-0" (1524 mm) pit. Contact your Otis sales representative for details.
 7. Please consult your local Otis representative regarding multi-car groups, or smaller dimensions.
 8. A pit ladder pocket may be required. Please contact your Otis representative for details.
 9. Hoistway widths for rises above 80'-0" (24384 mm) should be increased by 2" (51 mm) to allow for tolerances.
 10. Construction efficiencies can be realized by increasing hoistway width dimensions by 2" (51 mm).

11. Service cars with a 7'-9" (2362 mm) cab height and 4'-6" (1372 mm) pit will require an additional 8" (203 mm) of clear overhead.
IMPORTANT:
 To assist in your planning, we recommend that you call your Otis representative at the beginning of the project.

Center Opening Hoistway Plan

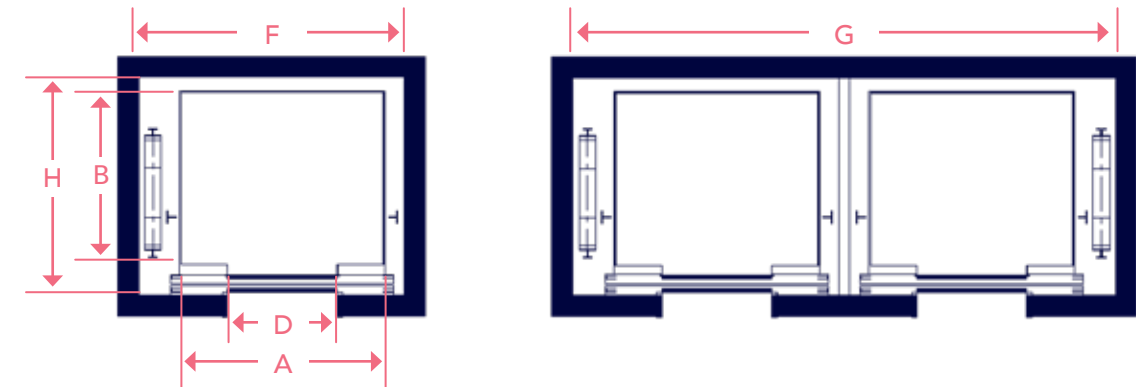

Single-Speed Side Slide Hoistway Plan

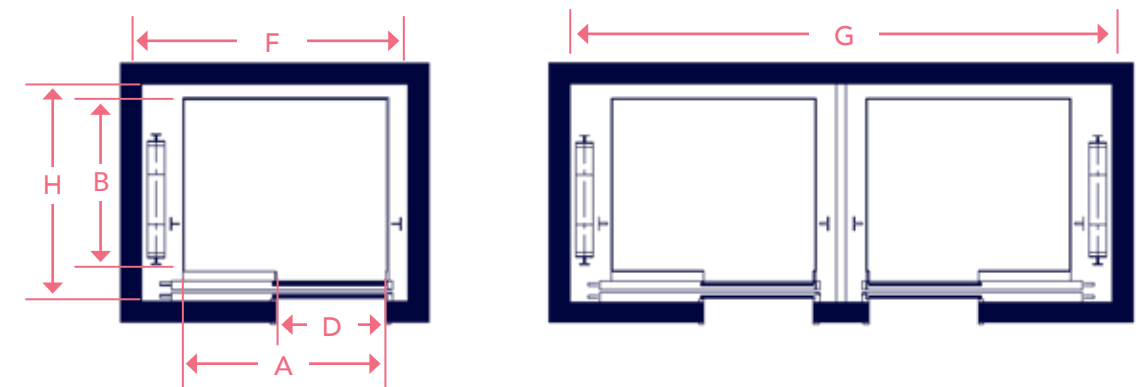

Elevation

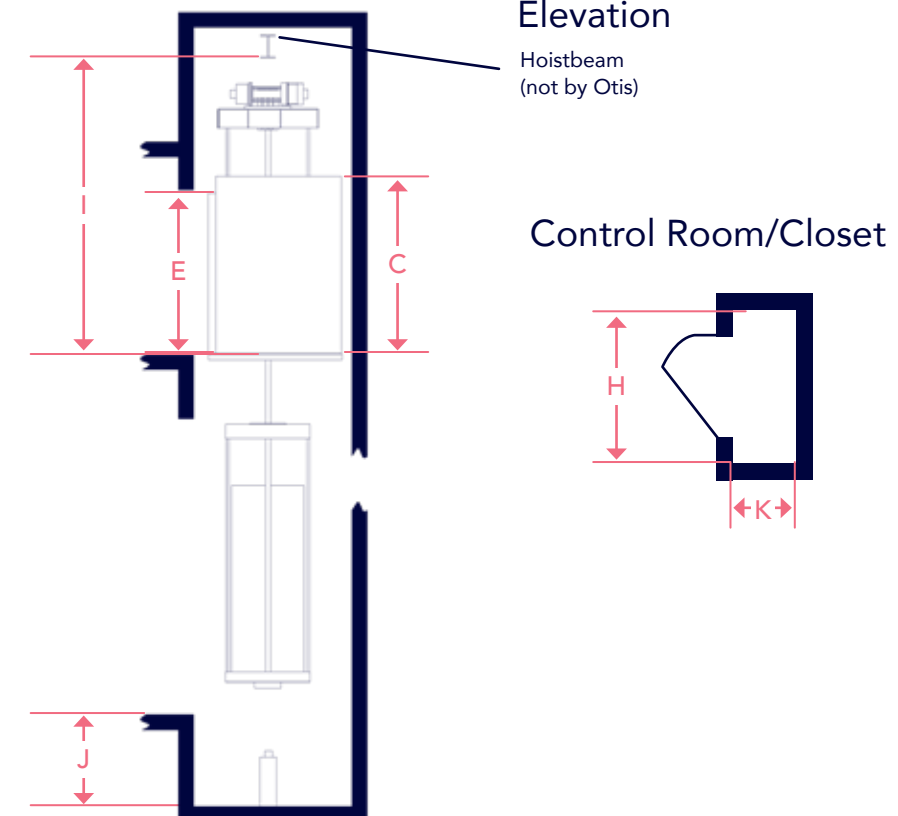

Gen3 Edge™

SERVICE ELEVATOR

Travel height maximum	80' (24 m)	150' (45 m)	150' (45 m)
Maximum stops	10	16	16
Speed (fpm)	150 (.76 m/s)	200 (1.02 m/s)	350 (1.78 m/s)
Capacity (lbs)	4,000 - 5,000		

Rated duty	4,000 lbs (1814 kg) ²	4,500 lbs (2041 kg) ²	5,000 lbs (2268 kg) ²	5,000 lbs AIA (2268 kg) ²
A Clear car width ¹	5'-5 9/16" (1655 mm)			
B Clear car depth for front openings ¹	7'-4 7/8" (2258 mm)	7'-10 15/16" (2241 mm)	8'-4 3/16" (2544 mm)	9'-0 1/8" (2747 mm)
Clear car depth for front & rear openings ¹	7'-5 1/2" (2273 mm)	7'-11 1/2" (2426 mm)	8'-4 3/4" (2559 mm)	9'-0 3/4" (2762 mm)
C Clear cab height ³	7'-9" (2362 mm) or 9'-9" (2972 mm)			
D Door width	4'-0" (1219 mm)		4'-6" (1372 mm)	
Door type	Two-speed			
E Door height	7'-0" (2134 mm) or 8'-0" (2438 mm)			
F Hoistway single width ^{9,10} non-seismic	7'-4" (2235 mm)		7'-10" (2388 mm)	7'-11" (2413 mm)
Hoistway single width ^{9,10} seismic	7'-6" (2286 mm)		8'-0" (2438 mm)	8'-1" (2464 mm)
G Hoistway double width ^{7,9,10} non-seismic	15'-0" (4572 mm)		16'-0" (4877 mm)	16'-2" (4928 mm)
Hoistway double width ^{7,9,10} seismic	15'-4" (4674 mm)		16'-4" (4978 mm)	16'-6" (5029 mm)
H Hoistway depth for front openings	9'-1" (2769 mm)	9'-7" (2921 mm)	10'-1" (3073 mm)	10'-8" (3251 mm)
Hoistway depth for front & rear openings	9'-10 1/2" (3009 mm)	10'-4 1/2" (3162 mm)	10'-9 3/4" (3295 mm)	11'-5 11/16" (3498 mm)

I Clear overhead to hoist beam ^{4,5}	150 fpm (10.76 m/s)	200 fpm (1.02 m/s)	350 fpm (1.78 m/s)
7'-9" (2362 mm) cab height	12'-10" (3912 mm)	12'-11" (3937 mm)	13'-7" (4140 mm) ¹¹
9'-9" (2972 mm) cab height	14'-10" (4522 mm)	14'-11" (4547 mm)	15'-7" (4750 mm)
J Minimum pit depth ^{6,8}	4'-0" (1219 mm) or 5'-0" (1524 mm)		4'-6" (1372 mm) or 5'-6" (1676 mm) ¹¹

K Optional control closet or room ⁷	
Control closet	Hoistway depth x 3'-10" (1168 mm)
Control room	Hoistway depth x 5'-9" (1753 mm)
Control room-duplex	Hoistway depth x 7'-6" (2286 mm)

1. Clear car dimensions may vary depending on interior finishes.
 2. 4000P and service elevators @350 fpm require a control closet.
 3. Clear cab height varies by ceiling type and floor recess.
 4. Allow a minimum of 4" (102 mm) between top of safety beam and top of hoistway.
 5. For seismic area, multi-car groups, or pre 2008 ASME A17.1 Safety Code for Elevators, please contact your Otis representative for clear overhead dimensions.

6. Some locations require a 5'-0" (1524 mm) pit. Contact your Otis sales representative for details.
 7. Please consult your local Otis representative regarding multi-car groups, or smaller dimensions.
 8. A pit ladder pocket may be required. Please contact your Otis representative for details.
 9. Hoistway widths for rises above 80'-0" (24384 mm) should be increased by 2" (51 mm) to allow for tolerances.
 10. Construction efficiencies can be realized by increasing hoistway width dimensions by 2" (51 mm).

11. Service cars with a 7'-9" (2362 mm) cab height and 4'-6" (1372 mm) pit will require an additional 8" (203 mm) of clear overhead.
IMPORTANT:
 To assist in your planning, we recommend that you call your Otis representative at the beginning of the project.

Two-Speed Side Slide Hoistway Plan

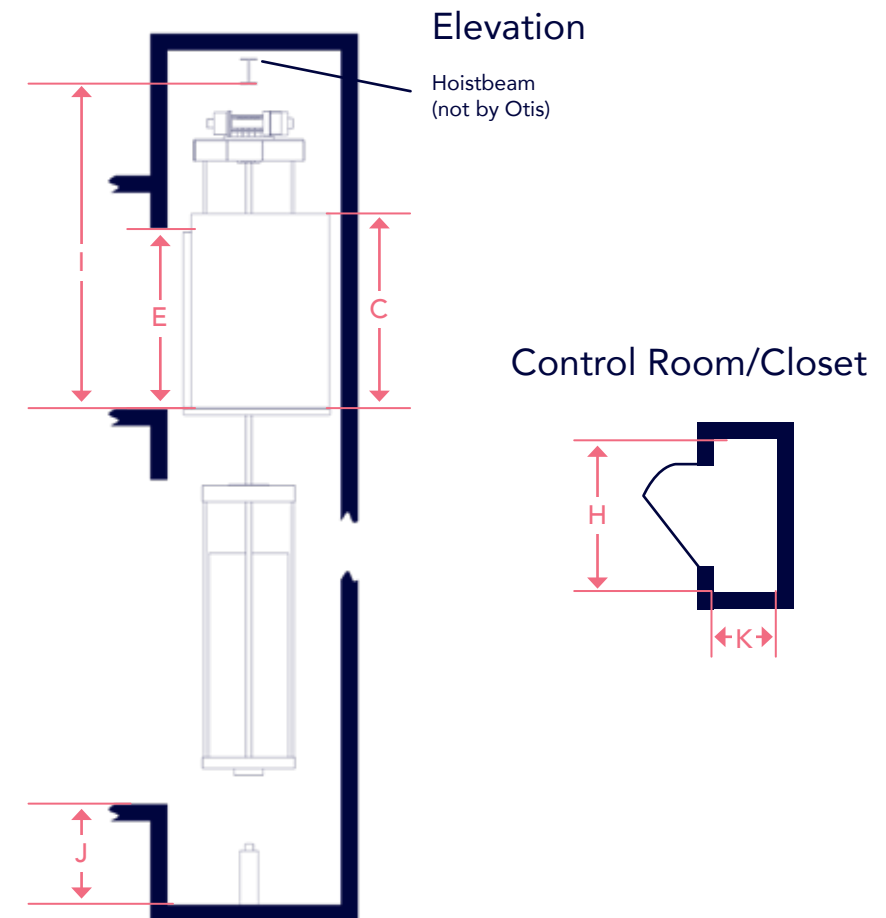
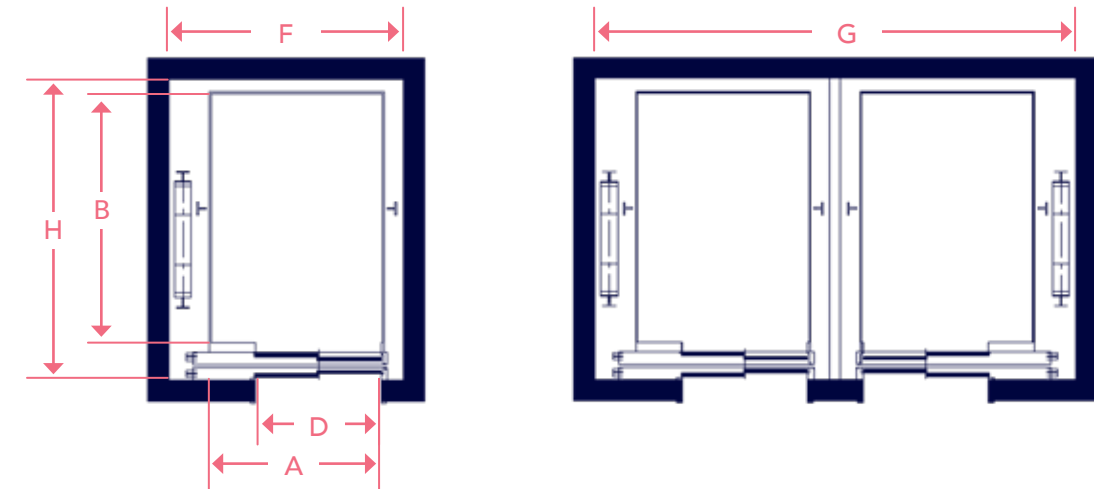

Gen3 Peak™

PASSENGER ELEVATOR

Travel height maximum	300' (91 m)				
Maximum stops	30				
Speed (fpm)	200 (1.02 m/s)	350 (1.78 m/s)	400 (2.03 m/s)	450 (2.29 m/s)	500 (2.54 m/s)
Capacity (lbs)	2,500 - 4,000				

Rated duty	2,500 lbs (1134 kg)	3,000 lbs (1361 kg)	3,500 lbs (1588 kg)	4,000 lbs (1814 kg)
A Clear car width ¹	6'-8 5/16" (2040 mm)			7'-8 5/16" (2345 mm)
B Clear car depth for front openings ¹	4'-3 1/8" (1299 mm)	4'-9" (1148 mm)	5'-5" (1651 mm)	
Clear car depth for front & rear openings ¹	4'-3 3/4" (1314 mm)	4'-9 5/8" (1463 mm)	5'-5 5/8" (1666 mm)	
C Clear cab height ²	8'-0" (2438 mm) or 9'-7" (2921 mm)			
D Door width	3'-6" (1067 mm)			4'-0" (1219 mm)
Door type	Center opening or single slide			Center opening
E Door height	7'-0" (2134 mm) or 8'-0" (2438 mm)			
F Hoistway single width non-seismic	8'-4" (2540 mm)			9'-4" (2845 mm)
Hoistway single width seismic	8'-6" (2591 mm)			9'-6" (2896 mm)
G Hoistway double width non-seismic	17'-0" (5182 mm)			19'-0" (5791 mm)
Hoistway double width seismic	17'-4" (5283 mm)			19'-4" (5893 mm)
H Hoistway depth for front openings	6'-6" (1981 mm)	7'-0" (2134 mm)	7'-8 1/2" (2350 mm)	
Hoistway depth for front & rear openings	6'-2 7/8" (1902 mm)	6'-8 3/4" (2051 mm)	7'-4 3/4" (2254 mm)	

I Total overhead ^{4,5}	200 fpm (1.02 m/s)	350 fpm (1.78 m/s) - 500 fpm (2.54 m/s)
8'-0" (2438 mm) cab height	15'-6" (4724 mm)	16'-2" (4928 mm)
9'-7" (2921 mm) cab height	17'-1" (5207 mm)	17'-9" (5410 mm)
J Minimum pit depth	5'-0" (1524 mm)	5'-6" (1676 mm)

K Optional control closet or room ³	
Control closet	Hoistway depth x 3'-10" (1168 mm)
Control room	Hoistway depth x 5'-9" (1753 mm)
Control room-duplex	Hoistway depth x 7'-6" (2286 mm)

1. Clear cab dimensions may vary depending on interior finishes.

2. Clear cab height varies by ceiling type.

3. Please consult your local Otis representative regarding multi-car groups or smaller dimensions.

4. For seismic areas, multi-car groups, or pre 2008 ASME A17.1 Safety Code for Elevators, please contact your Otis representative for clear overhead dimensions.

5. Overhead machine rooms are also available. Please contact your Otis representative.

IMPORTANT:

To assist in your planning, we recommend that you call your Otis representative at the beginning of the project.

Center Opening Hoistway Plan

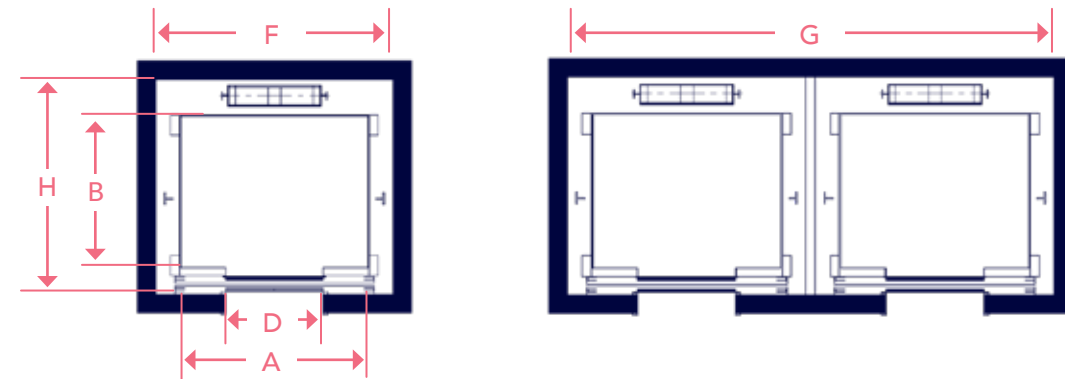

Single-Speed Side Slide Hoistway Plan

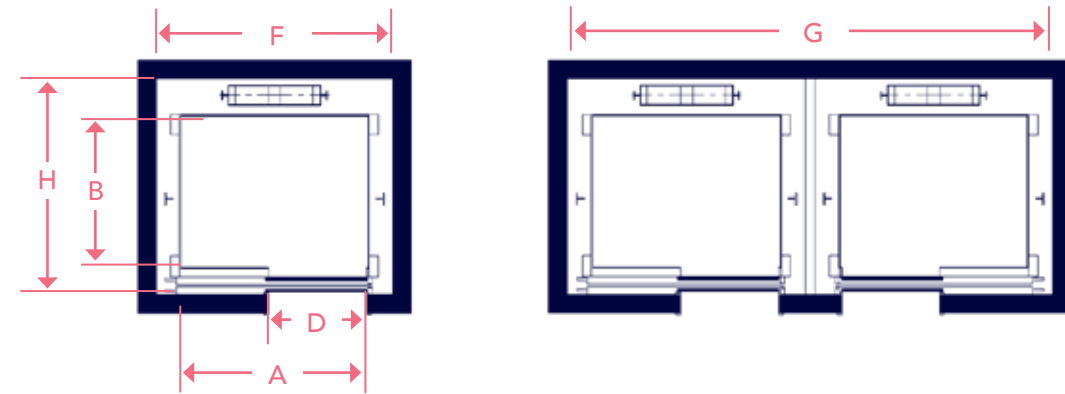

Elevation

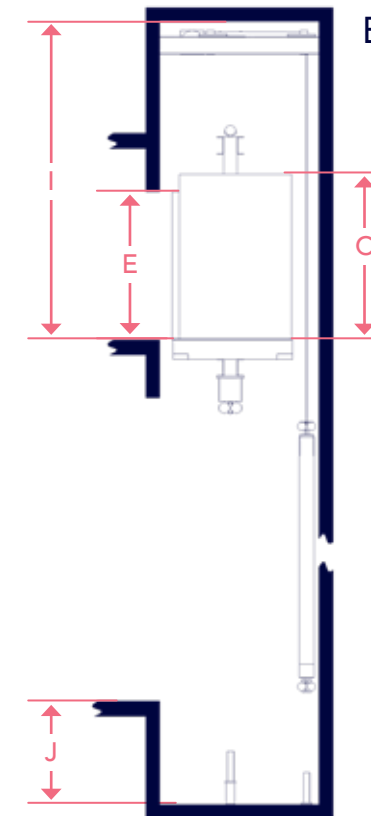

Control Room/Closet

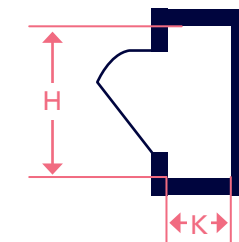

Gen3 Peak™

SERVICE ELEVATOR

Travel height maximum	300' (91 m)				
Maximum stops	30				
Speed (fpm)	200 (1.02 m/s)	350 (1.78 m/s)	400 (2.03 m/s)	450 (2.29 m/s)	500 (2.54 m/s)
Capacity (lbs)	4,000 - 5,000				

Rated duty	4,000 lbs (1814 kg)	4,500 lbs (2041 kg)	5,000 lbs (2268 kg)	5,000 lbs AIA (2268 kg)
A Clear car width ¹	5'-8 5/16" (1735 mm)		5'-11 5/16" (1811 mm)	5'-8 5/16" (1735 mm)
B Clear car depth for front openings ¹	7'-5" (2261 mm)	7'-11" (2413 mm)	8'-6" (2591 mm)	9'-0 1/8" (2747 mm)
Clear car depth for front & rear openings ¹	7'-5 5/8" (2276 mm)	7'-11 5/8" (2428 mm)	8'-6 5/8" (2606 mm)	9'-0 3/4" (2762 mm)
C Clear cab height ²	8'-0" (2438 mm) or 9'-7" (2921 mm)			
D Door width	4'-0" (1219 mm)		4'-6" (1371 mm)	
Door type	Two-speed			
E Door height	7'-0" (2134 mm) or 8'-0" (2438 mm)			
F Hoistway single width non-seismic	8'-2" (2489 mm)		8'-5" (2565 mm)	8'-2" (2489 mm)
Hoistway single width seismic	8'-4" (2540 mm)		8'-7" (2616 mm)	8'-4" (2540 mm)
G Hoistway double width non-seismic	16'-8" (5080 mm)		17'-2" (5232 mm)	16'-8" (5080 mm)
Hoistway double width seismic	17'-0" (5182 mm)		17'-6" (5534 mm)	17'-0" (5182 mm)
H Hoistway depth for front openings	9'-0" (2744 mm)	9'-6" (2896 mm)	10'-1" (3074 mm)	10'-7" (3227 mm)
Hoistway depth for front & rear openings	9'-10 5/8" (3013 mm)	10'-4 5/8" (3165 mm)	10'-11 5/8" (3343 mm)	11'-5 3/4" (3499 mm)

I Total overhead ^{4,5}	200 fpm (1.02 m/s)	350 fpm (1.78 m/s) - 500 fpm (2.54 m/s)
8'-0" (2438 mm) cab height	15'-6" (4724 mm)	16'-2" (4928 mm)
9'-7" (2921 mm) cab height	17'-1" (5207 mm)	17'-9" (5410 mm)
J Minimum pit depth	5'-0" (1524 mm)	5'-6" (1676 mm)

K Optional control closet or room ³	
Control closet	Hoistway depth x 3'-10" (1168 mm)
Control room	Hoistway depth x 5'-9" (1753 mm)
Control room-duplex	Hoistway depth x 7'-6" (2286 mm)

1. Clear cab dimensions may vary depending on interior finishes.
2. Clear cab height varies by ceiling type.
3. Please consult your local Otis representative regarding multi-car groups or smaller dimensions.

4. For seismic areas, multi-car groups, or pre 2008 ASME A17.1 Safety Code for Elevators, please contact your Otis representative for clear overhead dimensions.
5. Overhead machine rooms are also available. Please contact your Otis representative.

IMPORTANT:
To assist in your planning, we recommend that you call your Otis representative at the beginning of the project.

Two-Speed Side Slide Hoistway Plan

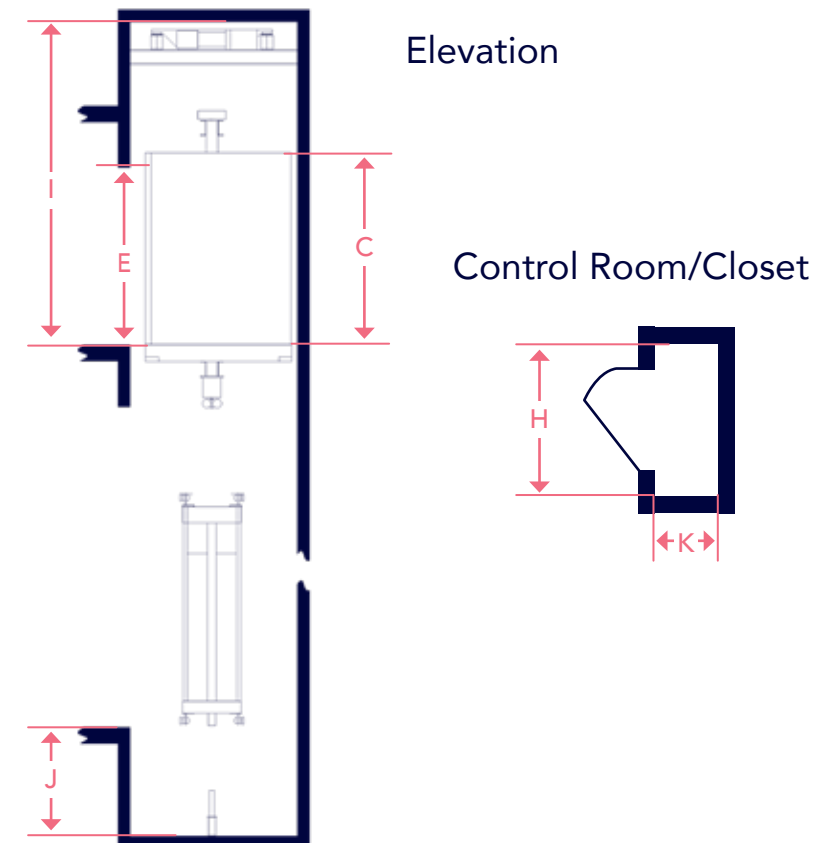
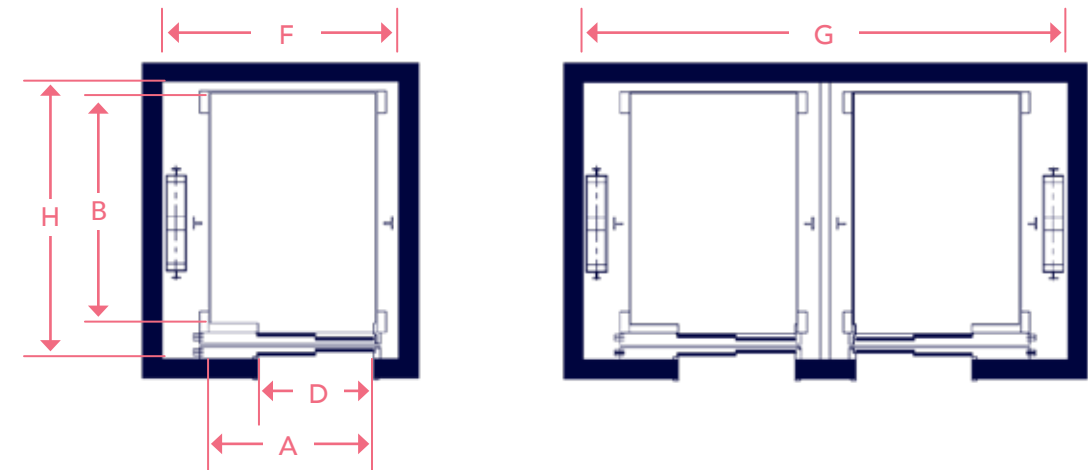

— Otis gives people freedom to connect and thrive in a taller, faster, smarter world. The global leader in the manufacture, installation and servicing of elevators and escalators, we move 2 billion people a day and maintain more than 2 million customer units worldwide – the industry's largest Service portfolio. You'll find us in the world's most iconic structures, as well as residential and commercial buildings, transportation hubs and everywhere people are on the move. Headquartered in Connecticut, USA, Otis is 69,000 people strong, including 40,000 field professionals, all committed to meeting the diverse needs of our customers and passengers in more than 200 countries and territories. To learn more, visit www.otis.com and follow us on LinkedIn, Instagram, Facebook and Twitter @OtisElevatorCo. All trademarks and logos are the intellectual property of their respective owners.